

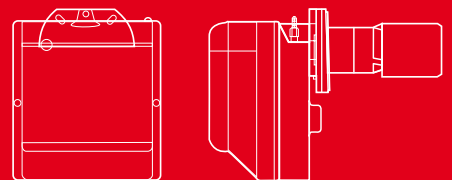

Gulliver BGD Series

Low NO_x Two Stage Light Oil Burners

| | | | | |
|--------|-----------|---|-------|----|
| BG6.1D | 53.8/65.8 | ÷ | 104 | kW |
| BG7.1D | 77.7/92 | ÷ | 149.5 | kW |



The Riello Gulliver BGD series of two stage light oil burners is a complete range of Low NO_x products, developed to respond to any request for home heating, conforming to the strictest standards governing the reduction of polluting emissions.

The Gulliver BGD series is available in two different models, with an output ranging from 53,8 to 149,5 kW, divided in two different structures.

All the models use the same components designed by Riello for the Gulliver series. The high quality level guarantees safe working. The Gulliver BGD burners are fitted with a microprocessor-based control box, with diagnostic functions.

In developing these burners, special attention was paid to reducing noise, to the ease of installation and adjustment, to obtaining the smallest size possible to fit into any sort of boiler available on the market.

The two stage operation guarantees high level of thermal unit efficiency.

All the models are approved by the EN 267 European Standard and conform to European Directives for EMC, Low Voltage, Machinery and Boiler Efficiency.

All the Gulliver BGD burners are fired before leaving the factory.

Technical Data

| MODEL | | BG6.1D | BG7.1D | |
|---------------------------------|--------------------------|--|----------------------------|------|
| Burner operation mode | | Two stage | | |
| Modulation ratio at max. output | | - | | |
| Servomotor | type | - | | |
| | run time s | - | | |
| Heat output | kW | 53.8/65.8 ÷ 104 | 77.7/92 ÷ 149.5 | |
| | Mcal/h | 46.3/56.6 ÷ 89.4 | 66.9/79.1 ÷ 128.6 | |
| | Kg/h | 4.5/5.5 ÷ 8.7 | 6.5/7.7 ÷ 12.5 | |
| Working temperature | °C min./max. | 0/40 | | |
| FUEL/AIR DATA | | | | |
| Light oil | net calorific value | kWh/kg | 11.8 | |
| | | kcal/kg | 10200 | |
| | viscosity at 20°C | mm ² /s (cSt) | 4 ÷ 6 | |
| Pump | type | R.B.L | | |
| | delivery at 12 bar | Kg/h | 30 | 30 |
| Atomised pressure | bar | 8 ÷ 15 | | |
| Fuel temperature | max. °C | 50 | | |
| Fuel pre-heater | | NO | | |
| Fan | type | Centrifugal with forward curve blades | | |
| Air temperature | max. °C | 40 | | |
| ELECTRICAL DATA | | | | |
| Electrical supply | Ph/Hz/V | 1/50/230 ± 10% | | |
| Auxiliary electrical supply | Ph/Hz/V | - | | |
| Control box | type | M0 550 | | |
| Total electrical power | kW | 0.39 | 0.47 | |
| Auxiliary electrical power | kW | - | | |
| Heaters electrical power | kW | - | | |
| Protection level | IP | X0D (IP 40) | | |
| Fan motor | electrical power | kW | 150 | 250 |
| | rated current | A | 1.9 | 1.85 |
| | start up current | A | - | - |
| | protection level | IP | 20 | |
| Pump motor | electrical power | kW | - | |
| | rated current | A | - | |
| | start up current | A | - | |
| | protection level | IP | - | |
| Ignition transformer | type | Incorporated in the control box | | |
| | V1 - V2 | (-) - 8 Kv | | |
| | I1 - I2 | (-) - 16 mA | | |
| Operation | | Intermittent (at least one stop every 24h) | | |
| EMISSIONS | | | | |
| Noise levels | Sound pressure | dB (A) | 63 | 69 |
| | Sound power | W | - | - |
| Light oil | CO emission | mg/kWh | 5 | 1 |
| | grade of smoke indicator | Nº Bacharach | < 1 | |
| | CxHy emission | mg/kWh | < 10 (after the first 20s) | |
| | NOx emission | mg/kWh | 102 | 110 |
| APPROVAL | | | | |
| Directive | | 2006/42/EC - 2009/142/EC - 2014/30/UE - 2014/35/UE | | |
| Conforming to | | EN 267 | | |
| Certification | | - | - | |

Reference conditions:

Temperature: 20°C - Pressure: 1013,5 mbar - Altitude: 0 m a.s.l. - Noise measured at a distance of 1 meter.

Since the Company is constantly engaged in the production improvement, the aesthetic and dimensional features, the technical data, the equipment and the accessories can be changed. This document contains confidential and proprietary information of RIELLO S.p.A. Unless authorised, this information shall not be divulged, nor duplicated in whole or in part.

Firing Rates

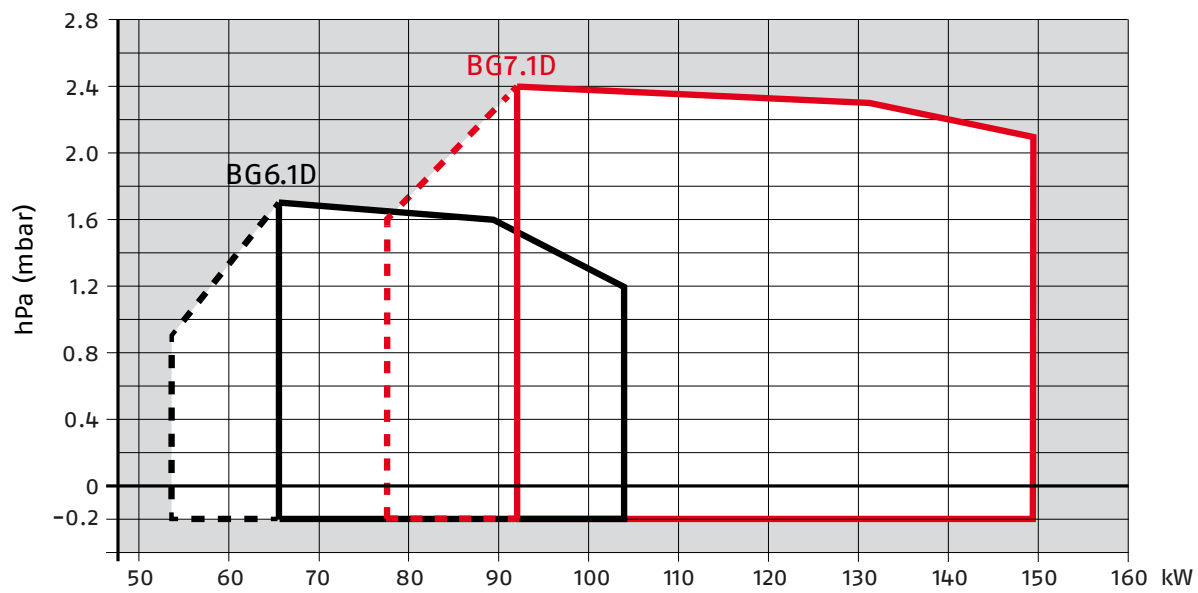

Useful working field for choosing the burner



1st stage operation range

Test conditions conforming to EN267:

Temperature: 20°C

Pressure: 1013,5 mbar

Altitude: 0 m a.s.l.

Fuel Supply

HYDRAULIC CIRCUIT

All the burners have a geared pump Riello with double safety valve on the return circuit.



Fuel pump

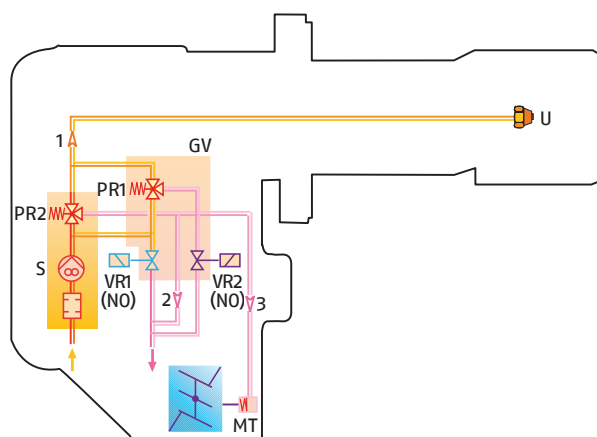

| | |
|-----------------|--|
| S | Pump with filter and pressure regulator on the delivery pipe |
| VR1 (NO) | 1 st stage oil return valve normally open |
| VR2 (NO) | 2 nd stage oil return valve normally open |
| 1 | Oil delivery pipe to the nozzle/s |
| 2 | Oil return pipe from the 2 nd stage regulator |
| 3 | Oil delivery pipe to the air damper hydraulic jack |
| MT | Air damper hydraulic jack for the 2 nd stage |
| PR1 | 1 st stage oil regulator |
| PR2 | 2 nd stage oil regulator |
| GV | Valve unit |
| U | Nozzle |

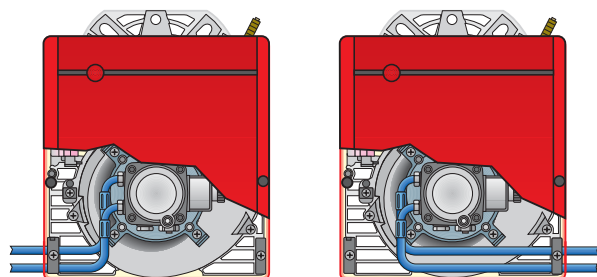

Fuel feed to the burner can be from the right or the left side on all models.

SELECTING THE FUEL SUPPLY LINES

The fuel feed must be completed with the safety devices required by the local regulations in force. The table shows the choice of piping diameter for the various burners, depending on the difference in the height between the burner and the tank and the distance between them.

| Maximum equivalent length of the pipework L (m) | | | | |
|--|----------------------|----------------------|----------------------|----------------------|
| | Type A system | | Type B system | |
| Pipe size | ∅ 8 mm | ∅ 10 mm | ∅ 8 mm | ∅ 10 mm |
| H (m) | L _{max} (m) | L _{max} (m) | L _{max} (m) | L _{max} (m) |
| 0 | 35 | 100 | - | - |
| 0.5 | 30 | 100 | 10 | 20 |
| 1.0 | 25 | 100 | 20 | 40 |
| 1.5 | 20 | 90 | 40 | 80 |
| 2.0 | 15 | 70 | 60 | 100 |
| 3.0 | 8 | 30 | - | - |
| 3.5 | 6 | 20 | - | - |

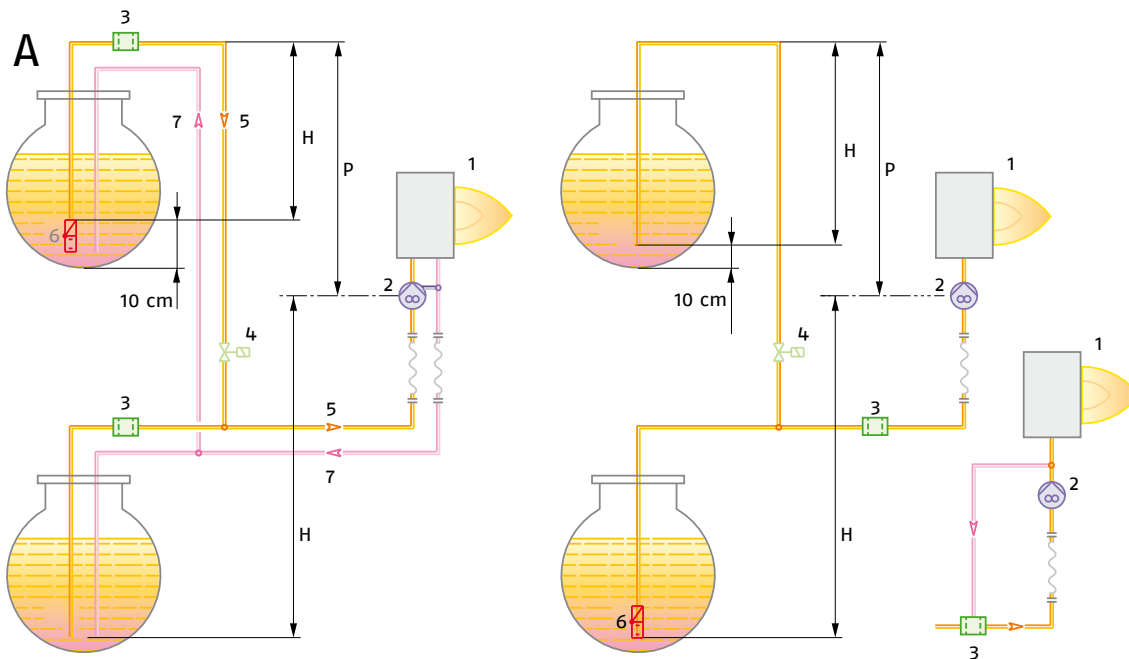

Type of system that can be installed

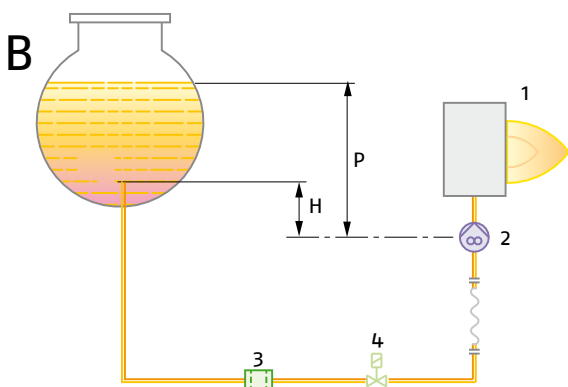

| | |
|----------|----------------------------|
| H | Difference in height |
| ∅ | Internal pipe diameter |
| P | Difference in height ≤ 4 m |
| 1 | Burner |
| 2 | Pump |
| 3 | Filter |
| 4 | Shut-off solenoid valve |
| 5 | Suction pipework |
| 6 | Bottom valve |
| 7 | Return pipework |

Ventilation

The different ventilation circuits always ensure low noise levels with high performance of pressure and air delivery, inspite of their compact size.



Air suction

Combustion Head

REDUCING FLAME TEMPERATURE

The configuration of the combustion head provokes internal re-circulation of the combustion substances. This re-circulation reduces the flame temperature and therefore the NOx emissions. Furthermore, re-circulation of the combustion substances speeds up evaporation of combustible droplets creating gassy type combustion, similar to gas burner blue flame.

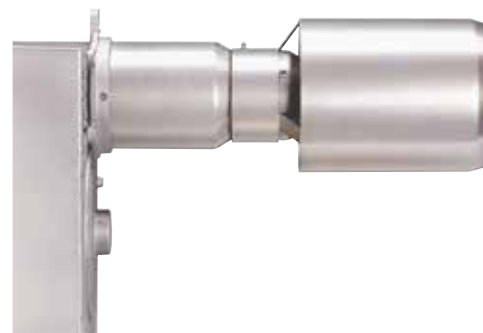
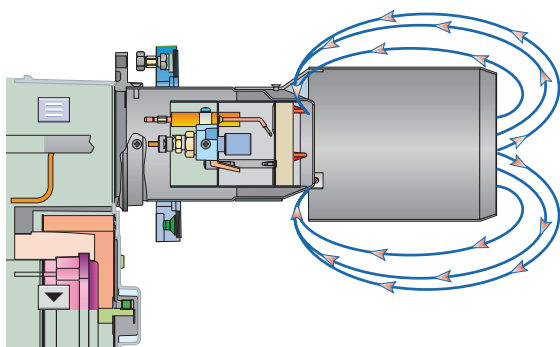

Combustion head

Dimensions of the flame

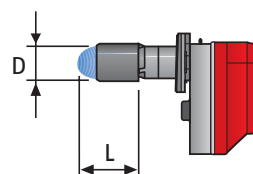
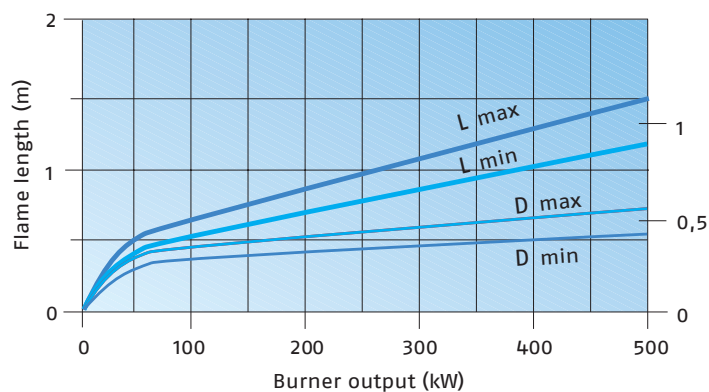

Example:
 Burner thermal output = 350 kW;
 L_{flame} (m) = 1.2 m (medium value);
 D_{flame} (m) = 0.6 m (medium value)

Operation

BURNER OPERATION MODE

All these models have two stage output operation.

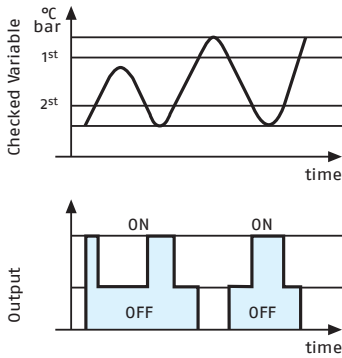

"Two stage" operation



Reduced output ignition device

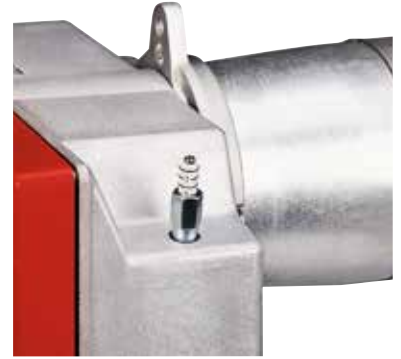

Air damper adjustment

The Gulliver BGD burner models are fitted with a new microprocessor control panel for the supervision during intermittent operation.

For helping the commissioning and maintenance work, there are two main elements:



The lock-out reset button is the central **operating element** for resetting the burner control and for activating / deactivating the diagnostic functions.



The multi-color LED is the central **indication element** for visual diagnosis and interface diagnosis.

Both elements are located under the transparent cover of lock-out reset button, as showed below.

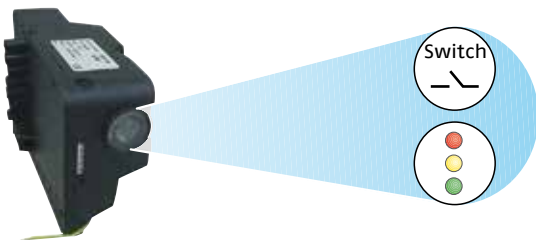

There are two diagnostic choices, for indication of operation and diagnosis of fault cause:

- visual diagnosis:

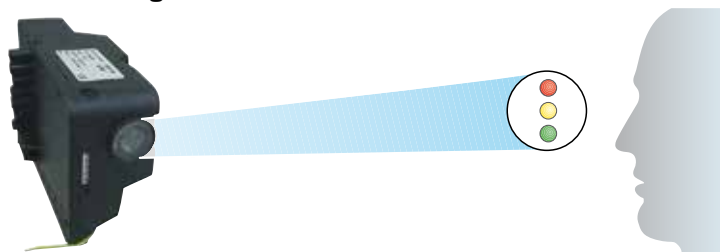

- interface diagnosis:

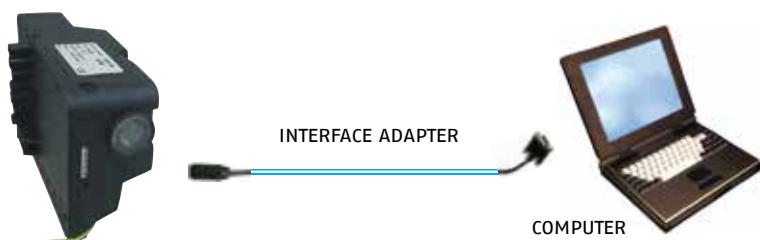

By the interface adapter and a PC with dedicated software.

Indication of operation:

In normal operation, the various status are indicated in the form of colour codes according to the table below.

Color code table

| Operation status | Color code | Flash type |
|--------------------------------------|--------------------------------------|------------|
| Stand-by | ○ Led off | |
| Pre-heating | ● Yellow continue | |
| Pre-purging | ● Green continue | |
| Ignition | ● ☀ Green continue + Yellow flashing | Fast |
| Flame OK | ● ☀ Green continue + Yellow flashing | Slow |
| Post purge | ● ☀ Green continue + Yellow continue | |
| Re-cycle | ● ☀ Green continue + Yellow flashing | Medium |
| Lock out | ● Red continue | Fast |
| Flame during pre-heating or stand-by | ☀ Yellow flashing | Fast |
| Flame during post-purge | ● ☀ Green continue + Yellow flashing | Fast |
| Flame during lock out | ● ☀ Red continue + Yellow flashing | |

Diagnosis of fault causes:



After lock-out has occurred, the red signal lamp is steady on. In this status, the visual fault diagnosis according to the error code table can be activated by pressing the lock-out reset button for > 3 seconds.

The control box sends a sequence of pulses that are repeated at 2-second intervals. The interface diagnosis (with adapter) can be activated by pressing again the lock-out button for > 3 seconds.

Example of flashes sequence:

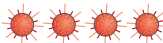

Error code table

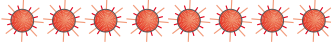
| Flash code | Possible cause of fault |
|--|--|
| 2 flashes  | No flame at the end of safety time : - faulty or soiled fuel valves - faulty or soiled flame detector - poor adjustment of burner, no fuel - faulty ignition |
| 4 flashes  | Extraneous light or presence of flame : - in stand-by position - with thermostat of heat demand in idle or working position - during oil-preheater - during pre-purge - during post-purge |
| 7 flashes  | Flame failure during running position after n° 3 attempts of re-cycle : - faulty or soiled fuel valves - faulty or soiled flame detector - soiled ignition electrodes - poor adjustment of burner, no fuel |
| 8 flashes  | Monitoring of oil-preheater : - faulty heater or oil-thermostat |

The M0550 digital control box gives some other advantages:

Post ignition

The spark ignition is present during all safety time and for supplementary time of 3 seconds.

Adjustable post purge

The Post-purge is a function that maintains air ventilation even after the burner is switched off.

Post-purge time can be set to a maximum of 6 minutes.

This function can be activated and set in a very easy way by pressing repeatedly the reset button; after 5 seconds the control box automatically shows the minutes set by the red LED flashing (1 pulse = post-ventilation for 1 minute).

If during post-purge there is a new request for heat, it is halted and a new operating cycle starts. The control box leaves the factory with the setting 0 minutes (no post-ventilation).

Remote lock-out reset

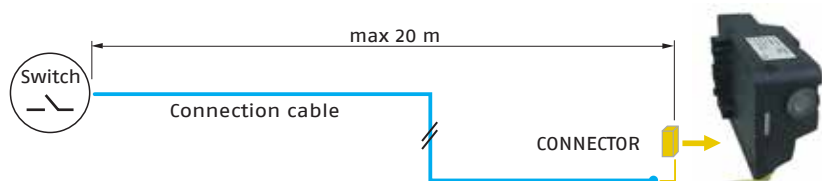

The 'Remote lock-out reset' is a function that allows to reset the control-box operation from a remote position. In the burner packages will be included a particular connector to remote the reset signal. The maximum length of connection must be 20 m.

START UP CYCLE

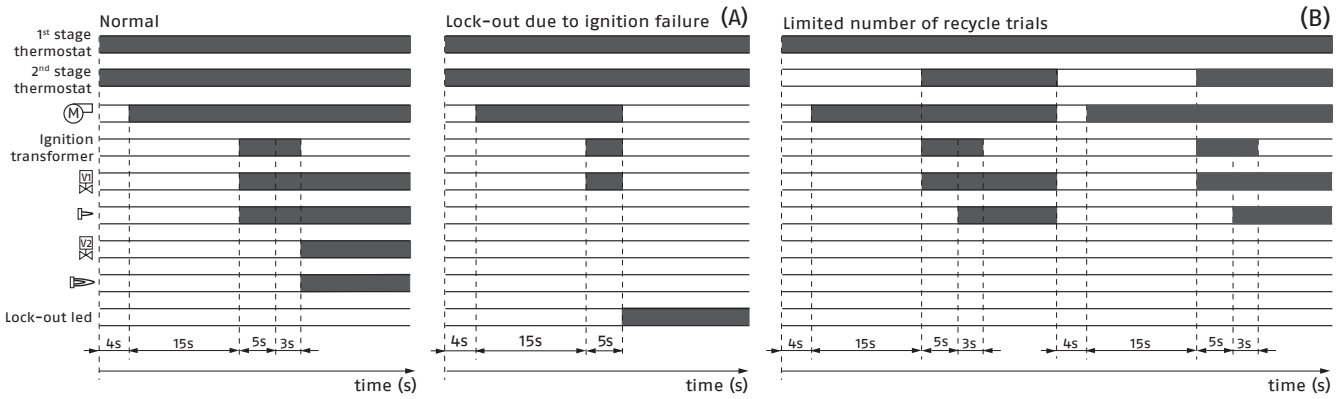

(A) Lock-out is shown by a led on the appliance.

(B) Total number of recycle trials is 3.

Correct operation

- 0s Start of heat demand the burner begins the ignition cycle
- 0s÷4s The burner is in stand-by
- 4s÷19s Pre-purge with air damper open
- 19s 1st stage ignition
- 19s÷24s Safety time
- 24s÷27s Post-ignition transformer time
- 27s 2nd stage ignition

Lock-out due to ignition failure

If the flame does not light within the safety limit (~5s) the burner locks-out.

Re-cycle

The burner permits maximum three repetitions of complete ignition cycle if there is flame failure during operation. The burner goes in safety shut-down within one second. The final action at the last trial following at last flame failure is a lock-out.

Emissions

The emission data have been measured in the various models at maximum output, in conformity with EN 267 standard.

NO2 EMISSIONS

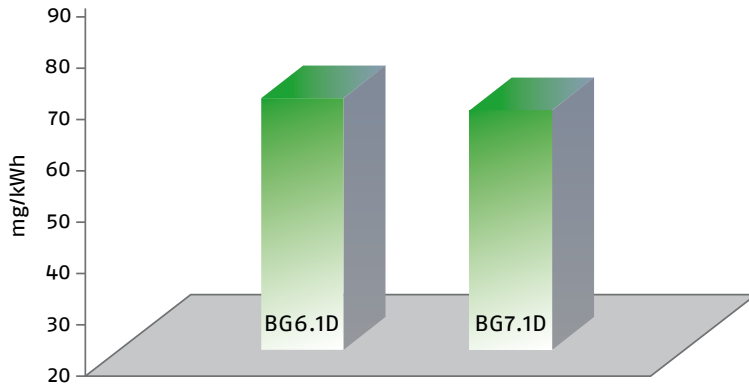

CO EMISSIONS

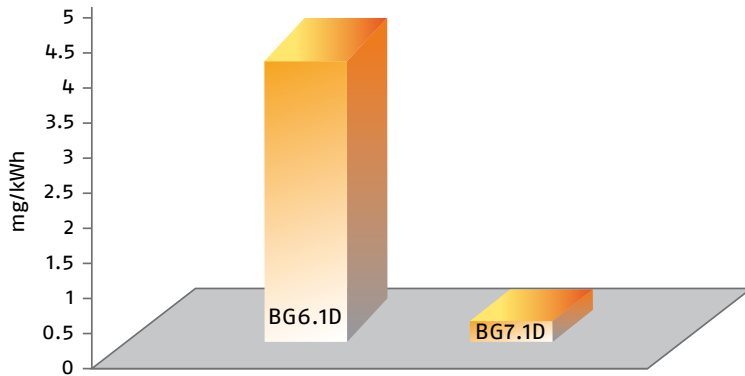

SOUND EMISSIONS (sound pressure)

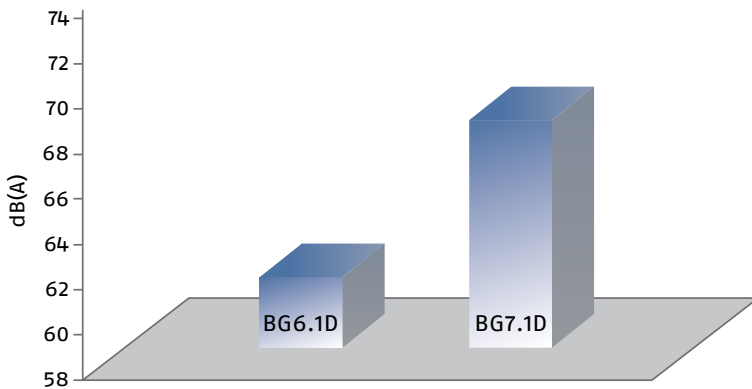

Special attention has been paid to noise reduction. All models are fitted with sound-proofing material inside the cover.

Overall Dimensions (mm)

These models are distinguished by their reduced size, in relation to their output, which means they can be fitted to any boiler on the market.

BURNER

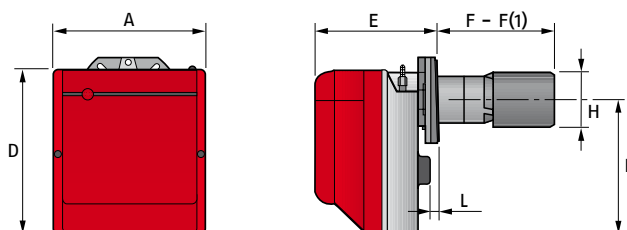

| MODEL | A | D | E | F | F(1) | H | I | L |
|--------|-----|-----|-----|-----|------|-----|-----|----|
| BG6.1D | 300 | 345 | 228 | 284 | 363 | 131 | 285 | 12 |
| BG7.1D | 300 | 345 | 347 | 394 | - | 165 | 285 | 12 |

BURNER - BOILER MOUNTING FLANGE

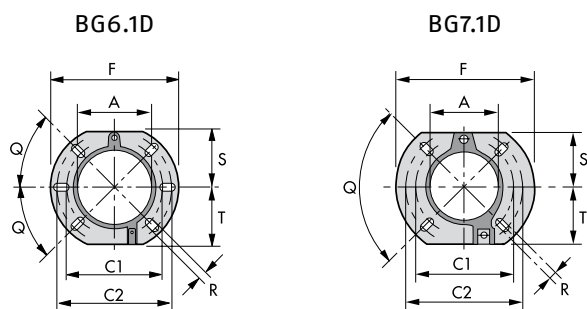

| MODEL | A | C1 | C2 | F | Q | R | S | T |
|--------|-----|-----|-----|-----|-----|----|----|----|
| BG6.1D | 106 | 140 | 170 | 189 | 45° | 11 | 83 | 83 |
| BG7.1D | 127 | 160 | 190 | 213 | 90° | 11 | 99 | 99 |

PACKAGING

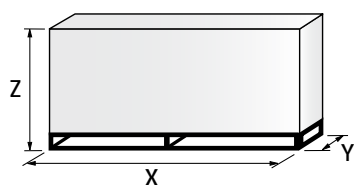

| MODEL | X | Y | Z | kg |
|--------|-----|-----|-----|----|
| BG6.1D | 600 | 345 | 430 | 20 |
| BG7.1D | 600 | 345 | 430 | 20 |

Installation Description

Skilled and qualified personnel must perform installation, start up and maintenance. A nozzle is fitted to the burner and used for fire tests in the factory. If necessary, change the nozzle on the basis of the maximum output of the boiler. All operations must be carried out as described in the technical handbook supplied with the burner.

BURNER SETTING

2nd stage air damper position adjustment can be made without removing the burner casing.



1st stage air damper position adjustment.



Head setting area is easily accessible and the operation is simple thanks to a graduated scale.



MAINTENANCE AND ELECTRICAL CONNECTIONS

The nozzle holder can be serviced through the rear cover, without detaching the burner from the boiler.



The 7-pole socket is incorporated in the control box, the 4-pole socket is already connected.



The 4 and 7-pin plugs are also supplied for connection to the boiler.



Burner accessories

LIGHT OIL FILTER



For cleaning light oil from dirty particles and impurities filters with the following features are available:

| BURNER | FILTERING DEGREE (μm) | CODE |
|------------|---------------------------------------|---------|
| All models | 60 | 3006561 |

Filter made up of aluminium body and stainless steel filtering cartridge; available singularly.

| BURNER | FILTERING DEGREE (μm) | CODE |
|------------|---------------------------------------|---------|
| All models | 60 | 3075011 |

Filter made up of aluminium cover, plastic tank and nylon filtering cartridge; available in packaging of 50 pieces.

LIGHT OIL FILTER/DEGASSING UNIT



To solve problems of air or water in the oil circuit a special filter/degassing unit is available, made up of aluminium cover, plastic tank, stainless steel filtering cartridge, air release cap and water purge valve. It is available singularly.

| BURNER | FILTERING DEGREE (μm) | CODE |
|------------|---------------------------------------|---------|
| All models | 100 | 3000926 |

7-PIN PLUG KIT

If necessary a 7-pin plug kit is available (in packaging of n. 5 pieces).

| BURNER | CODE |
|------------|---------|
| All models | 3000945 |

PC INTERFACE KIT



To connect the control box to a personal computer for the transmission of operation, fault signals and detailed service information, an interface adapter with PC software are available.

| BURNER | CODE |
|------------|---------|
| All models | 3002731 |

Specification

DESIGNATION OF SERIES

A specific index guides your choice of burner from the various models available in the BS series. Below is a clear and detailed specification description of the product.

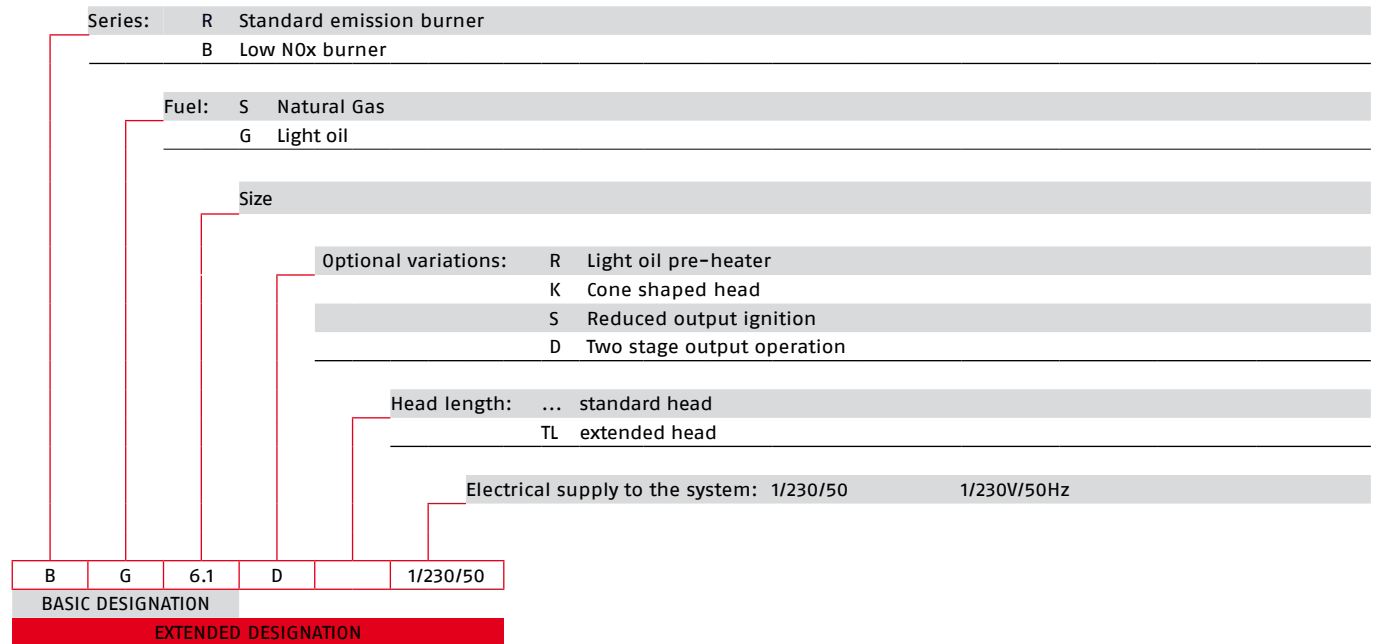

AVAILABLE BURNER MODELS

| BURNER MODELS | ELECTRICAL SUPPLY | HEAT OUTPUT | | TOTAL ELECTRICAL POWER (kW) | CERTIFICATION | NOTE |
|---------------|-------------------|-----------------|----------------|-----------------------------|---------------|------|
| | | (kW) | (kg/h) | | | |
| BG6.1D | 1/230/50 | 53.8/65.8 - 104 | 4.5/5.5 - 8.7 | 0.39 | - | - |
| BG6.1D TL | 1/230/50 | 53.8/65.8 - 104 | 4.5/5.5 - 8.7 | 0.39 | - | - |
| BG7.1D | 1/230/50 | 77.7/92 - 149.5 | 6.5/7.7 - 12.5 | 0.47 | - | - |

Net calorific value: 11,8 kWh/kg; 10200 kcal/kg - Viscosity at 20°C: 4+6 mm²/s (cSt).
 The burners of BG series are in according to EN 267.

SPECIFICATION

STATE OF SUPPLY

Burner

Completely automatic monobloc light oil burners, two stage operation, made up of:

- Fan with forward curve blades
- Cover lined with sound-proofing material
- Air damper completely closed in stand by
- Air damper, with 1st and 2nd stage adjustment (2nd stage adjustment without removing the casing)
- Single phase electric motor 230 V, 50 Hz
- Combustion head fitted with:
 - stainless steel head cone, resistant to high temperatures
 - ignition electrodes
 - flame stability disk
- Geared pump for fuel supply, fitted with:
 - filter
 - pressure regulator
 - attachments for fitting a pressure gauge and vacuum meter
 - internal by-pass for preparing for single-pipe installations
- Fuel feed solenoid valve incorporated in the pump
- IRD for flame detection
- Microprocessor-based burner safety control box M0 550, with diagnostic and remote control release functions
- Protection filter against radio interference (included into burner safety control box)
- Light oil nozzle
- IP X0D (IP 40) protection level

Standard equipment

- Two flexible pipes for connection to the light oil supply line
- Two nipples for connection to the pump
- Flange, screws and nuts for fixing
- Thermal screen
- 7-pin plug
- 4-pin plug
- Instruction handbook for installation, use and maintenance
- Spare parts catalogue

Conforming to:

- 2014/30 UE Directive (electromagnetic compatibility)
- 2014/35 UE Directive (low voltage)
- 2006/42 EC Directive (machine)
- EN 267 (liquid fuel burners)

Available accessories to be ordered separately:

- Light oil filter
- Light oil filter/degassing unit
- 7-pin plug kit
- PC interface kit

Riello Burners a world of experience in every burner we sell.

05/2016

T500004UK03



[1]

Across the world, Riello sets the standard in reliable and high efficiency burner technology.

With burner capacity from 5 kW to 48 MW, Riello gas, oil, dual fuel and Low Nox burners deliver unbeatable performance across the full range of residential and commercial heating applications, as well as in industrial processes.

With headquarter in Legnago, Italy, Riello has been manufacturing premium quality burners for over 90 year. The manufacturing plant is equipped with the most innovative systems of assembling lines and modern manufacturing cells for a quick and flexible response to the market.



[2]

Besides, the Riello Combustion Research Centre, located in Angiari, Italy, represents one of the most modern facility in Europe and one of the most advanced in the world for the development of the combustion technology.

Today, the company's presence on worldwide markets is distinguished by a well-constructed and efficient sales network, alongside many important Training Centres located in various countries to meet its customers' needs. Riello has 13 operational branches abroad (in Europe, America and Asia), with customers in over 60 countries.

[1] BURNERS PRODUCTION PLANT
S. PIETRO, LEGNAGO (VERONA) – ITALIA

[2] HEADQUARTER BURNERS DIVISION
S. PIETRO, LEGNAGO (VERONA) – ITALIA

RIELLO S.p.A. - 37045 Legnago (VR) - Italy
tel. +39 0442 630111 - fax: +39 0442 21980
www.riello.com

Since the Company is constantly engaged in the production improvement, the aesthetic and dimensional features, the technical data, the equipment and the accessories can be changed. This document contains confidential and proprietary information of RIELLO S.p.A. Unless authorised, this information shall not be divulged, nor duplicated in whole or in part.

RIELLO